

ELECTRICAL DRAWINGS

FOR

TENDER FOR A CONTRACTOR TO SUPPLY AND INSTALL
BOLLARDS, FENCING AND BOOM FACILITIES FOR THE
SECURE LANDSIDE PARKING PROJECT AT GEORGE
AIRPORT, FOR A PERIOD OF 6 MONTHS

Bid Reference Number: GRJ7501/2024/RFP

January 2025

VOLUME 3

Issued by
Airports Company South Africa
George Airport



Prepared by

BDE

RAADGEWENDE INGENIEURS
CONSULTING ENGINEERS

■ KAAPSTAD P.O. BOX 53036 KENILWORTH 7745 TEL. (021) 696 4065
■ GEORGE P.O. BOX 1862 GEORGE 6530 TEL. (044) 801 9700
■ E-MAIL bde@bdeconsult.co.za



Prepared for



V3 CONSULTING
ENGINEERS

T : +27 (0) 44 691 2305
email : mosselbaai@v3consulting.co.za

4 Mascador Street, Voor Bay, Mossel Bay, 6506
PO Box 730, Mossel Bay, 6500, South Africa



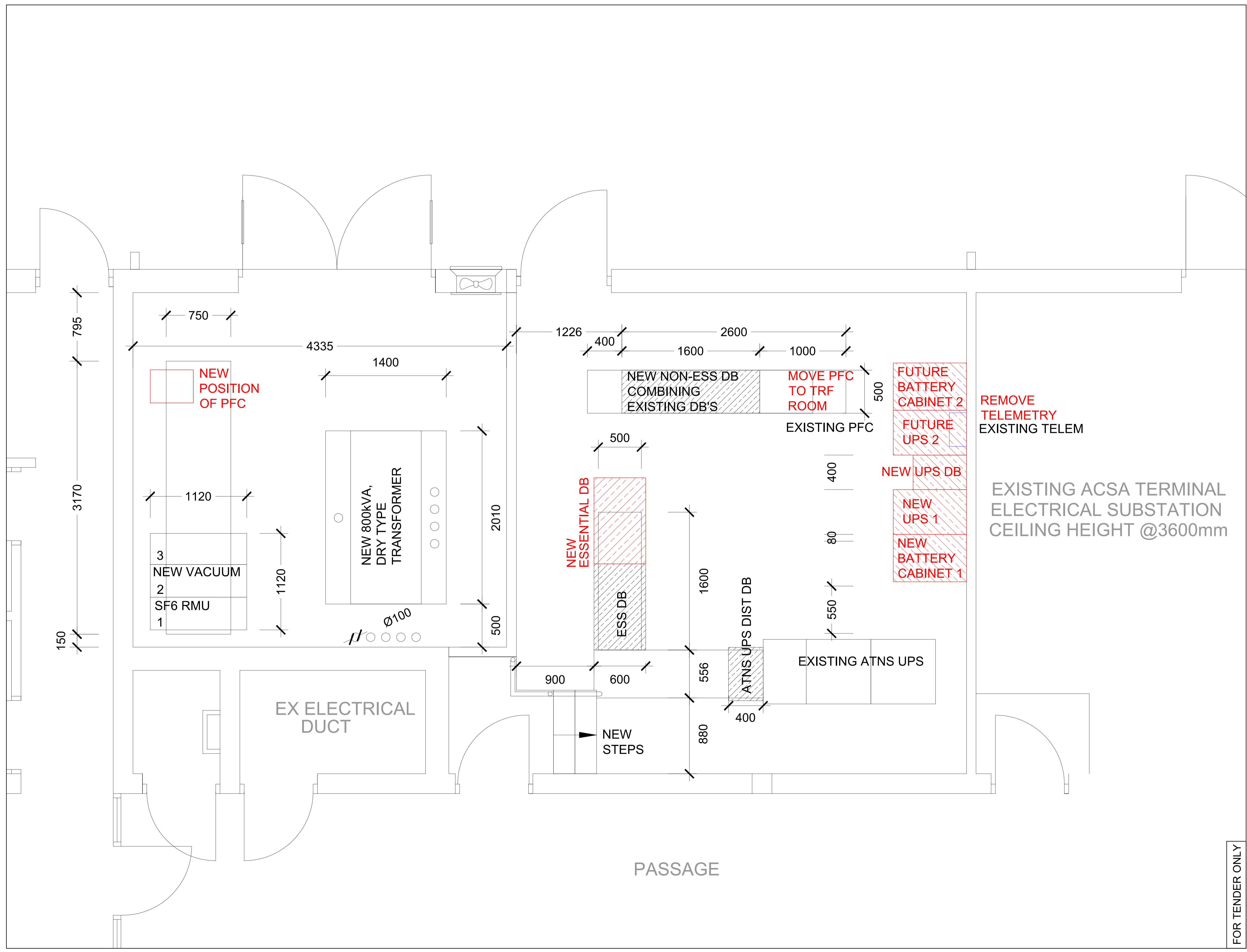

NR.	DATUM	WYSIGINGS
0	2024/08/22	FOR INFORMATION ONLY
1	2024/11/18	FOR TENDER ONLY

Copyright of drawings:
 This drawing is the property of BDE Consult & the copyright therein vests in BDE Consult & may not be copied in whole or in part, nor may the technical contents be used for any reason whatsoever without the written permission of BDE Consult.
 The drawing shall be returned to BDE Consult on request.

General Notes:
 This drawing is to be read in conjunction with relevant layout drawings, specification & BOQ.
 The contractor / OEM vendor to submit shop drawings & fabrication drawings for client / consultant's approval before commencement of fabrication / procuring components.

KLIENT / CLIENT
ACSA

BDE
 RAADGEWENDE INGENIEURS
 CONSULTING ENGINEERS

■ KAAPSTAD P.O. BOX 53038 KENILWORTH 7745 TEL. (021) 696 4065
 ■ GEORGE P.O. BOX 1862 GEORGE 6530 TEL. (044) 811 9700
 ■ E-MAIL info@bdeconsult.co.za

CESA

PROJIEK / PROJECT
ACSA LANDSIDE PARKING SECURITY

TEKENING BESKRIVING / DRAWING DESCRIPTION
TERMINAL SUBSTATION LAYOUT

TEKENING NR. / DRAWING NO.	REV
GRG-510/RT/BL/04	1

HUIDIGE DATUM / CURRENT DATE	GOEDGEKEUR / APPROVED
2024/11/18	
SKAAL / SCALE	A1 - 1:20 NAGEGAAN / CHECKED
A3 - 1:40	CHECKED
LEER NR. / FILE NO.	00510 GRG CAD NAGEGAAN / CAD CHECKED
AANVANGSDATUM / COMMENCE DATE	2024 GETEKEN / DRAWN
	UDJ

FOR TENDER ONLY

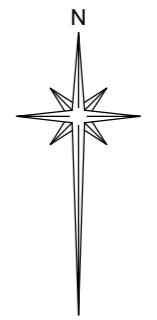
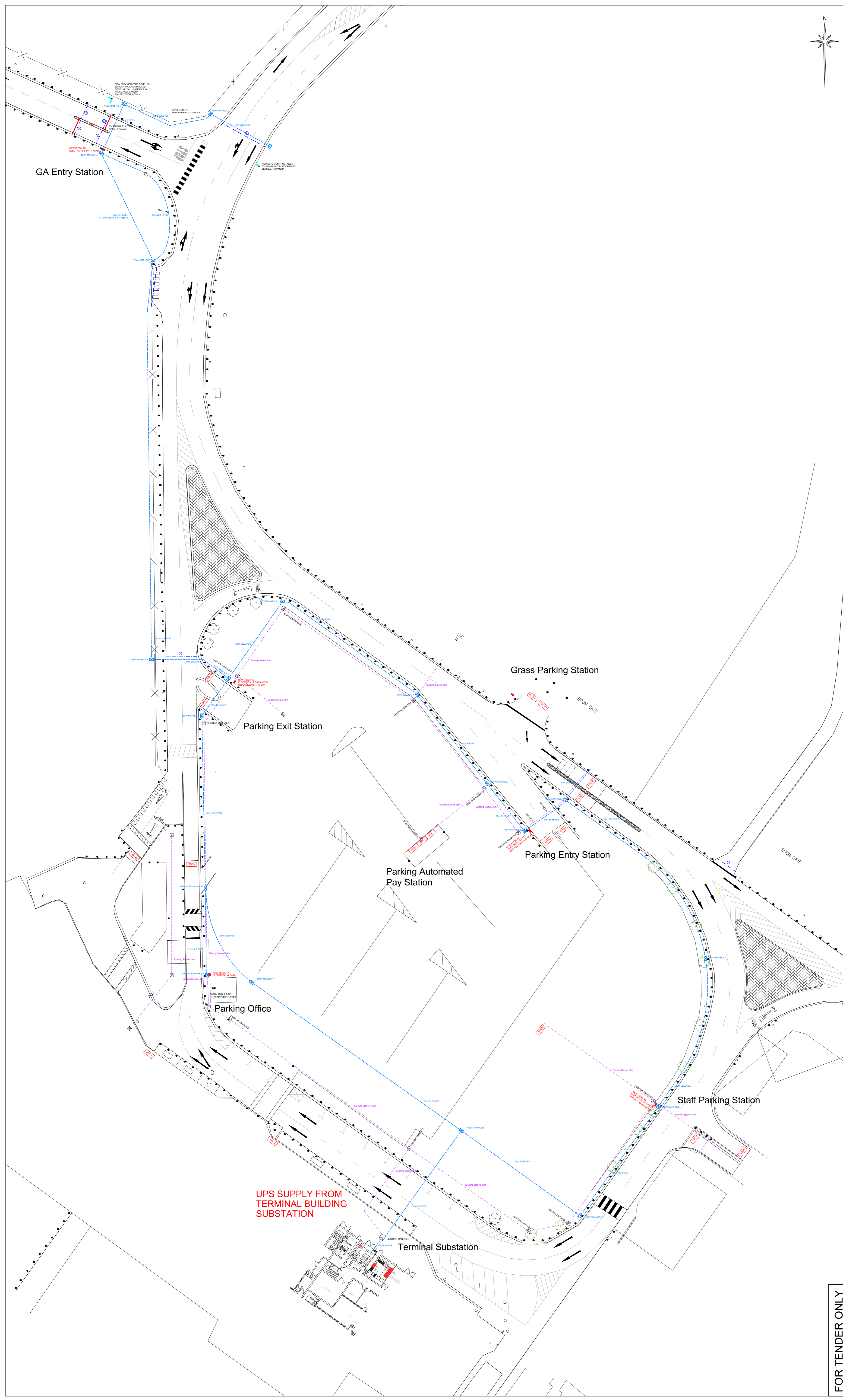

LEGEND	
NEW SLEEVE ROUTE (3x 110mm CORRUGATED SLEEVES)	
EXISTING SLEEVE ROUTE (50mm PVC SLEEVES)	
2 DOOR POLYURETHANE KIOSK GREY FRONT POWER & REAR DATA	
NEW (900mm x 600mm) MANHOLES	
EXISTING (450x450) MANHOLES	
1, 2 OR 3 x Ø110mm CORRUGATED SLEEVES 1 x GREEN SLEEVE WITH EACH CROSSING	

NR.	DATUM DATE	WYSIGINGS AMENDMENTS
0	2024/09/18	FOR INFORMATION ONLY
1	2024/11/18	FOR TENDER ONLY

Copyright of drawings:
This drawing is the property of BDE Consult & the copyright therein vests in BDE Consult & may not be copied in whole or in part, nor may the technical contents be used for any reason whatsoever without the written permission of BDE Consult.
The drawing shall be returned to BDE Consult on request.

General Notes:
This drawing is to be read in conjunction with relevant layout drawings, specification & BOG.
The contractor / OEM vendor to submit shop drawings & fabrication drawings for client / consultant's approval before commencement of fabrication / procuring components.

KLIJENT / CLIENT
ACSA

BDE
RAADGEWENDE INGENIEURS
CONSULTING ENGINEERS

■ KAAPSTAD P.O. BOX 53036 KENILWORTH 7745 TEL. (021) 696 4065
■ GEORGE P.O. BOX 1862 GEORGE 6530 TEL. (044) 801 9700
■ E-MAIL: info@bdeconsult.co.za

PROJEK / PROJECT
ACSA LANDSIDE PARKING SECURITY

TEKENING BESKRYWING / DRAWING DESCRIPTION
ELECTRICAL & DATA SLEEVE RETICULATION LAYOUT

TEKENING NR. / DRAWING NO.	REV
GRG-510/RT/DS/03	1

HUIDIGE DATUM CURRENT DATE	2024/11/18	GOEDGEKEUR APPROVED
SKAAL SCALE	A1 - 1:400 A3 - 1:800	NAGEGAAN CHECKED
LEIR NR. FILE NO.	00510 GRG	CAD NAGEGAAN CAD CHECKED
AANVANGSDATUM COMMENCE DATE	2024	GETEKEN DRAWN UDU

FOR TENDER ONLY

UPS SUPPLY FROM TERMINAL BUILDING SUBSTATION

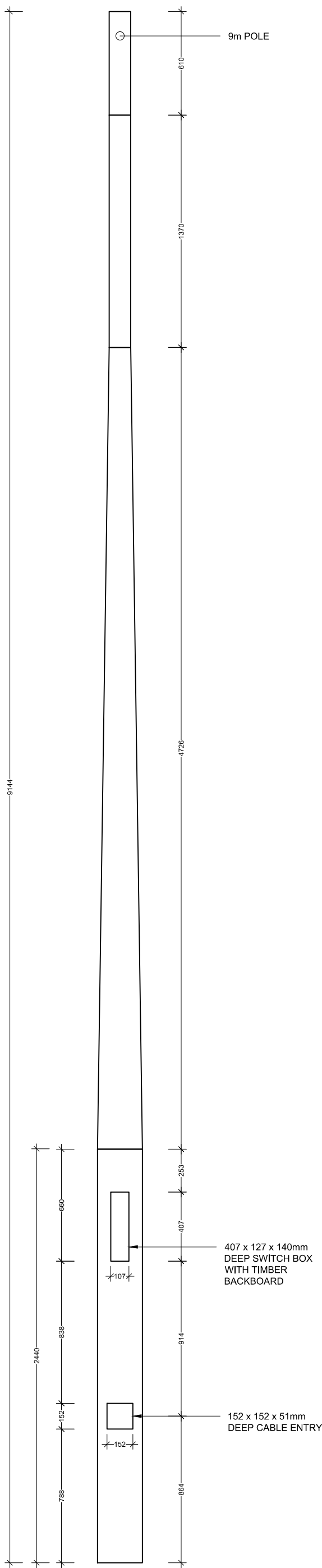

NOTES:

CABLE ENTRIES ARE 152 x 152 x 51 mm, TWO CAN BE PROVIDED BACK TO BACK.

SWITCH BOXES HAVE WOODEN BACKBOARDS WITH DIMENSIONS PROVIDED BELOW AND INCLUDE A PVC PLASTIC DOOR WITH ALLEN KEY SCREWS.

9,00 M POLE 407 x 127 x 140mm DEEP.

STANDARDS ILLUSTRATED ARE DESIGNED TO COMPLY WITH S.A.B.S 470 - 2003 OF THE FOLLOWING CLASSES:

CLASS 4 PROOF LOAD 9.144 POLE - 1.30kN

NR. NO.	DATUM DATE	WYSIGINGS AMENDMENTS
0	2024/08/22	FOR INFORMATION ONLY
1	2024/11/18	FOR TENDER ONLY

Copyright of drawings:

This drawing is the property of BDE Consult & the copyright therein vests in BDE Consult & may not be copied in whole or in part, nor may the technical contents be used for any reason whatsoever without the written permission of BDE Consult. The drawing shall be returned to BDE Consult on request.

General Notes:

This drawing is to be read in conjunction with relevant layout drawings, specification & BOQ. The contractor / OEM vendor to submit shop drawings & fabrication drawings for client / consultant's approval before commencement of fabrication / procuring components.

KLIENT / CLIENT

ACSA



RAADGEWENDE INGENIEURS CONSULTING ENGINEERS

- KAAPSTAD P.O.BOX 53036 KENILWORTH 7745 TEL. (021) 696 4065
- GEORGE P.O.BOX 1862 GEORGE 6530 TEL. (044) 801 9700
- E-MAIL bde@bdeconsult.co.za



PROJEK / PROJECT

ACSA LANDSIDE PARKING SECURITY

TEKENING BESKRYWING / DRAWING DESCRIPTION

CCTV CONCRETE POLE DETAIL

TEKENING NR. / DRAWING NO.

GRG-510/RT/DT/05

REV

1

HUIDIGE DATUM CURRENT DATE	2024/11/18	GOEDGEKEUR APPROVED	
SKAAL SCALE	A3 - 1:25	NAGEGAAN CHECKED	
LE&R NR. FILE NO.	00510 GRG	CAD NAGEGAAN CAD CHECKED	
AANVANGSDATUM COMMENCE DATE	2024	GETEKEN DRAWN	UDJ

FOR TENDER ONLY

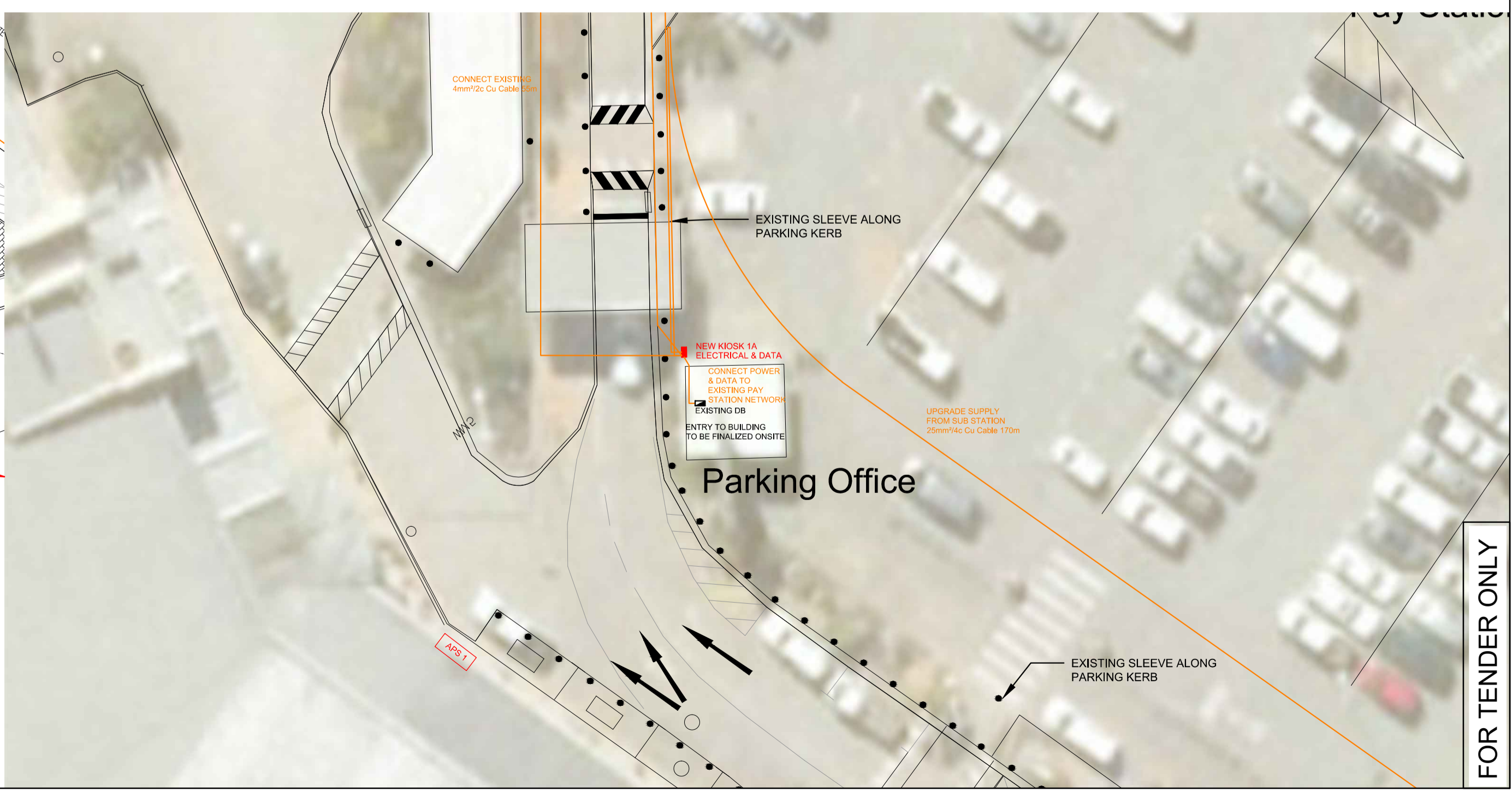
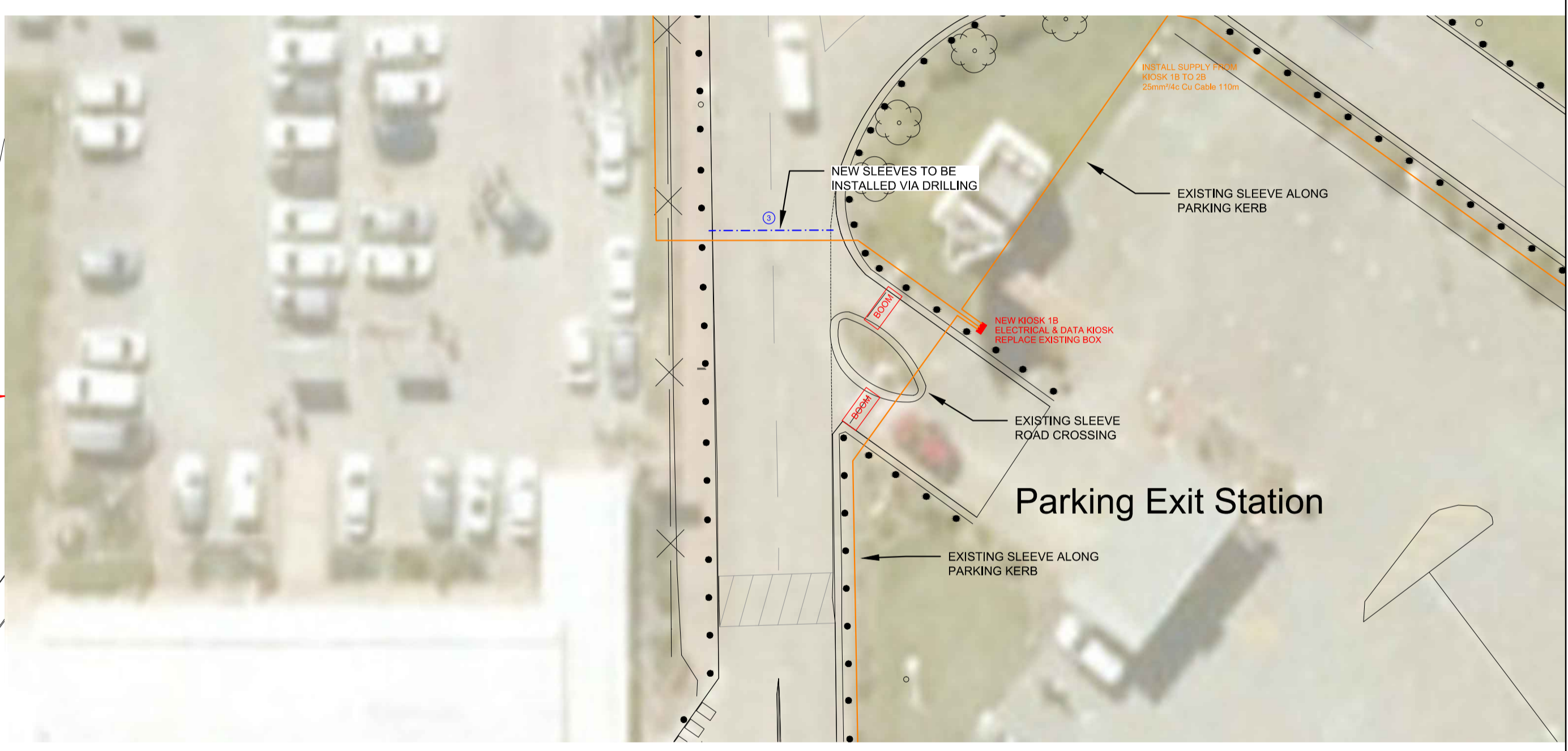
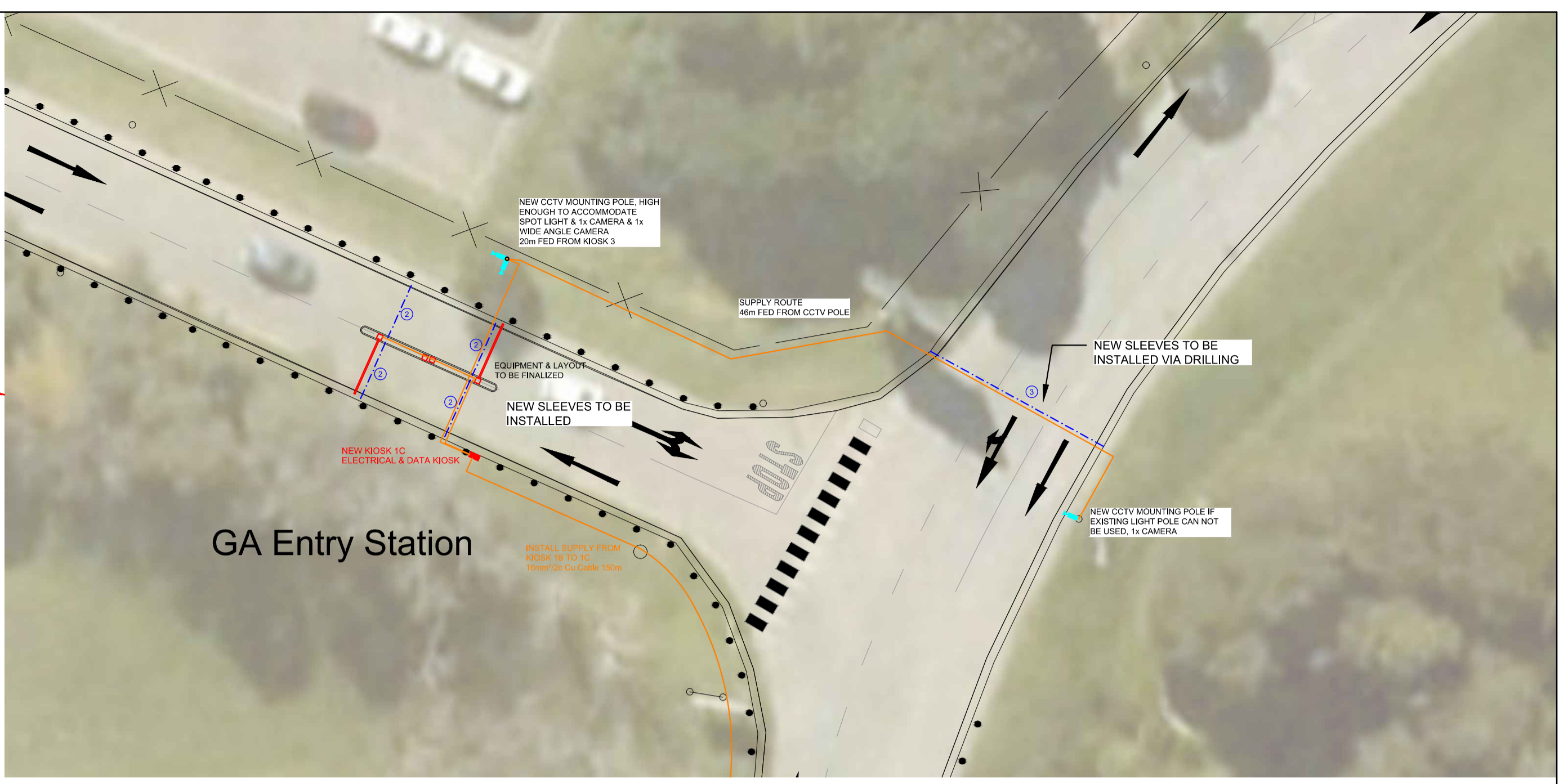
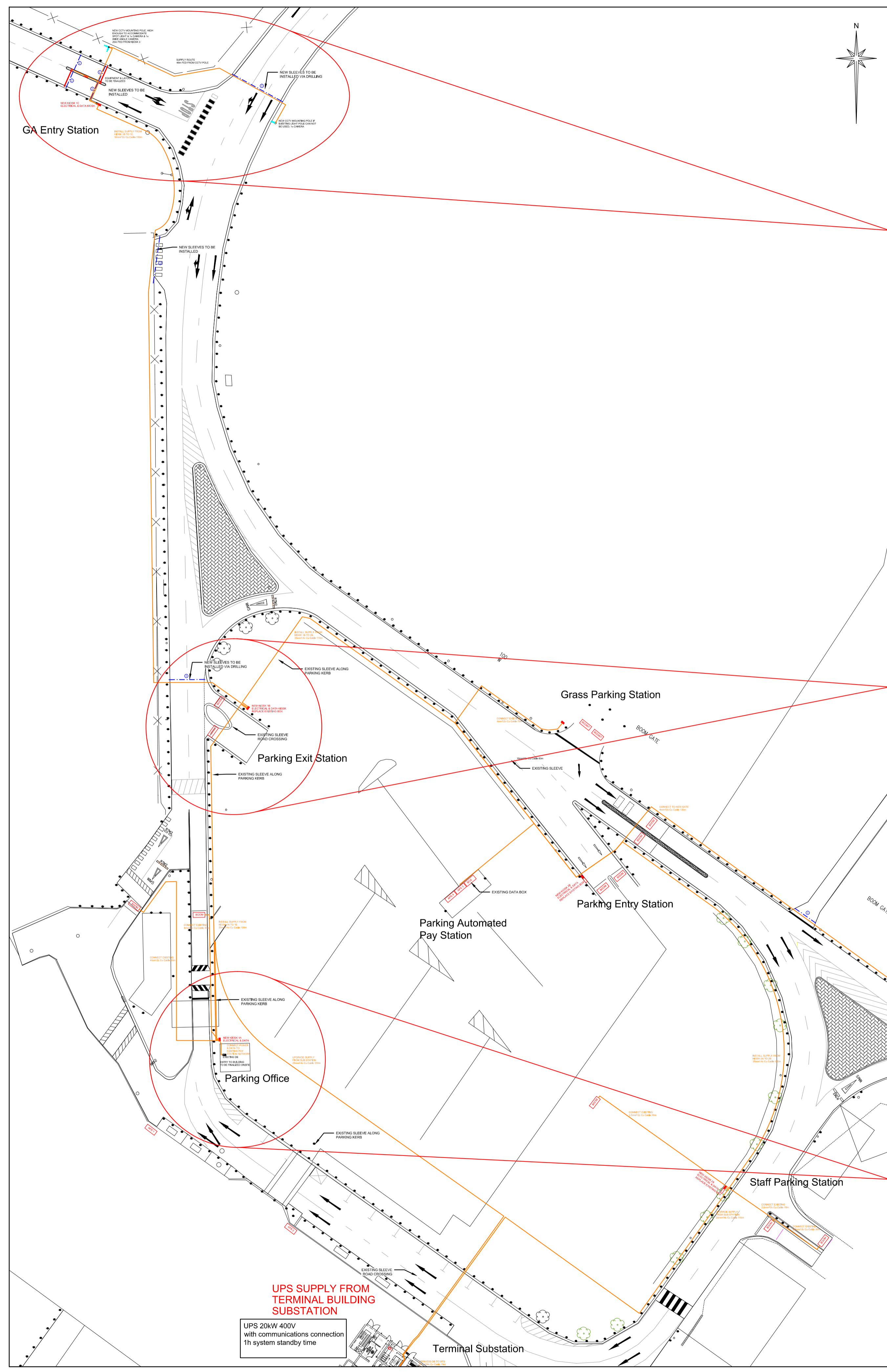

LEGEND	
UNDERGROUND CABLE ROUTE AS INDICATED	
2 DOOR POLYURETHANE KIOSK GREY FRONT POWER & REAR DATA	
EXISTING AUTOMATED PAY STATION	
EXISTING BOOM	
EXISTING DATA KIOSK	
NEW BOOM	
NEW TICKET DISPENSER / ACCEPTOR	
1, 2 OR 3 x Ø110mm CORRUGATED SLEEVES 1 x GREEN SLEEVE WITH EACH CROSSING	

NR.	DATE	WYSIGINGS AMENDMENTS
0	2024/05/10	FOR INFORMATION ONLY
1	2024/11/18	FOR TENDER ONLY

Copyright of drawings:
This drawing is the property of BDE Consult & the copyright therein vests in BDE Consult & may not be copied in whole or in part, nor may the technical contents be used for any reason whatsoever without the written permission of BDE Consult. The drawing shall be returned to BDE Consult on request.

General Notes:
This drawing is to be read in conjunction with relevant layout drawings, specification & BOQ.
The contractor / OEM vendor to submit shop drawings & fabrication drawings for client / consultant's approval before commencement of fabrication / procuring components.

CLIENT / CLIENT
ACSA

BDE
RAADGEWENDE INGENIEURS
CONSULTING ENGINEERS

■ KAAPSTAD P.O. BOX 53038 KENILWORTH 7745 TEL. (021) 696 4065
■ GEORGE P.O. BOX 1862 GEORGE 6530 TEL. (044) 811 9700
■ E-MAIL info@bdeconsult.co.za

PROJEC / PROJECT
ACSA LANDSIDE PARKING SECURITY

TEKENING BESKRYWING / DRAWING DESCRIPTION
LV & DATA RETICULATION LAYOUT

TEKENING NR. / DRAWING NO.	REV
GRG-510/RT/LV/01	1

HIJDIGE DATUM / CURRENT DATE	GOEDGEKEUR / APPROVED
2024/11/18	
SKAAL / SCALE	NAGEGAAN / CHECKED
A1 - 1:500/250	A3 - 1:1000/500
LEER NR. / FILE NO.	CAD NAGEGAAN / CAD CHECKED
00510 GRG	
AANVANGSDATUM / COMMENCE DATE	GETEKEN / DRAWN
2024	UDJ

FOR TENDER ONLY

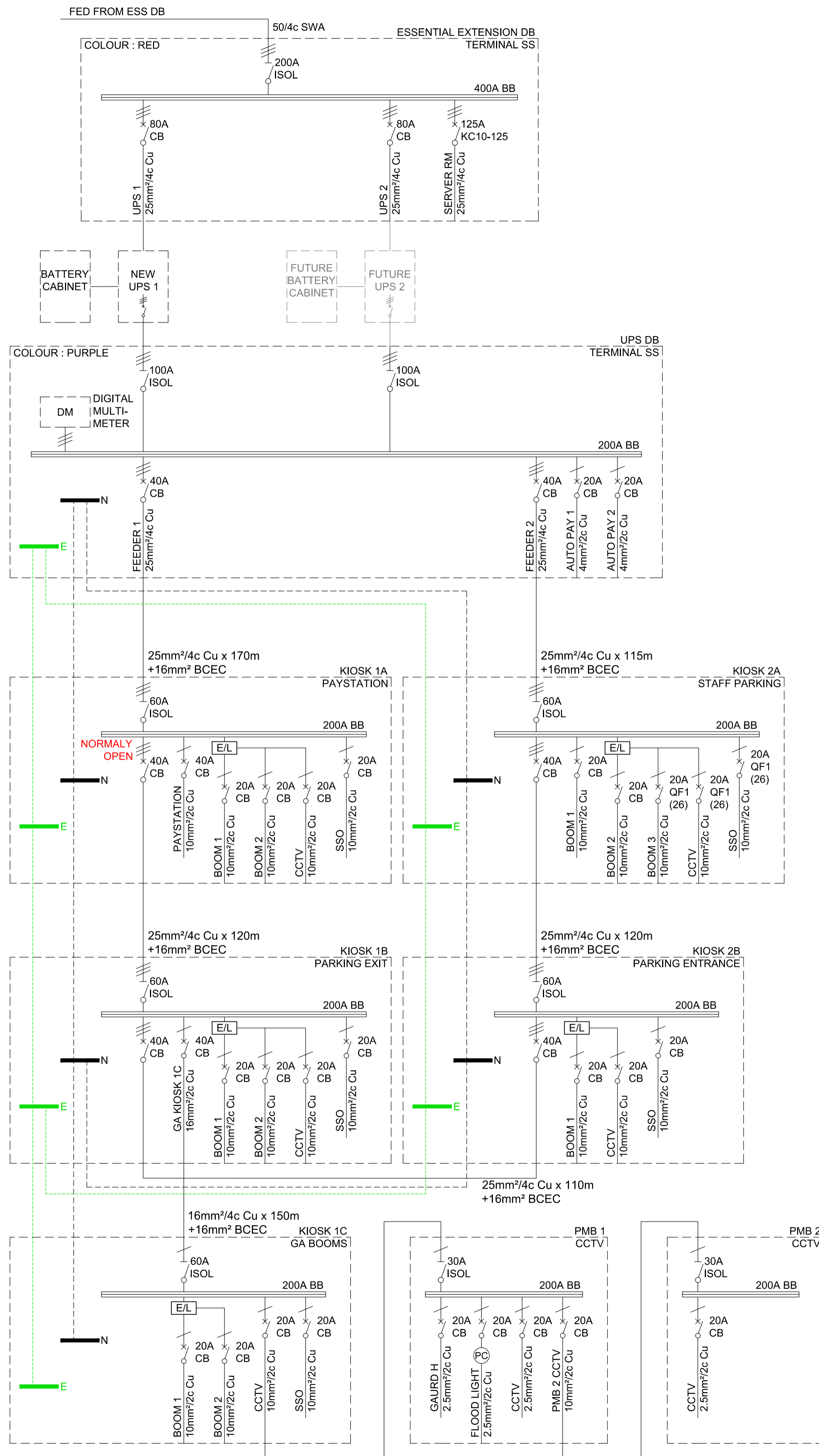

RETICULATION SCHEMATIC LAYOUT

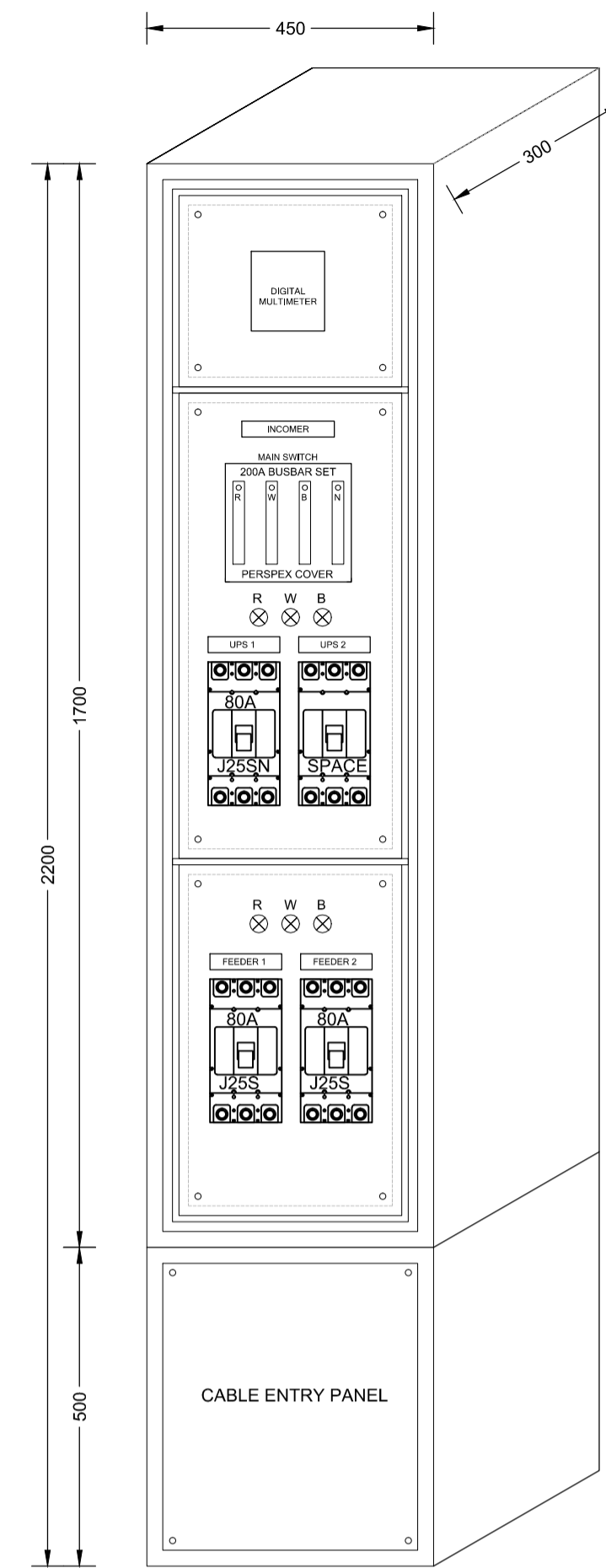

UPS DISTRIBUTION BOARD

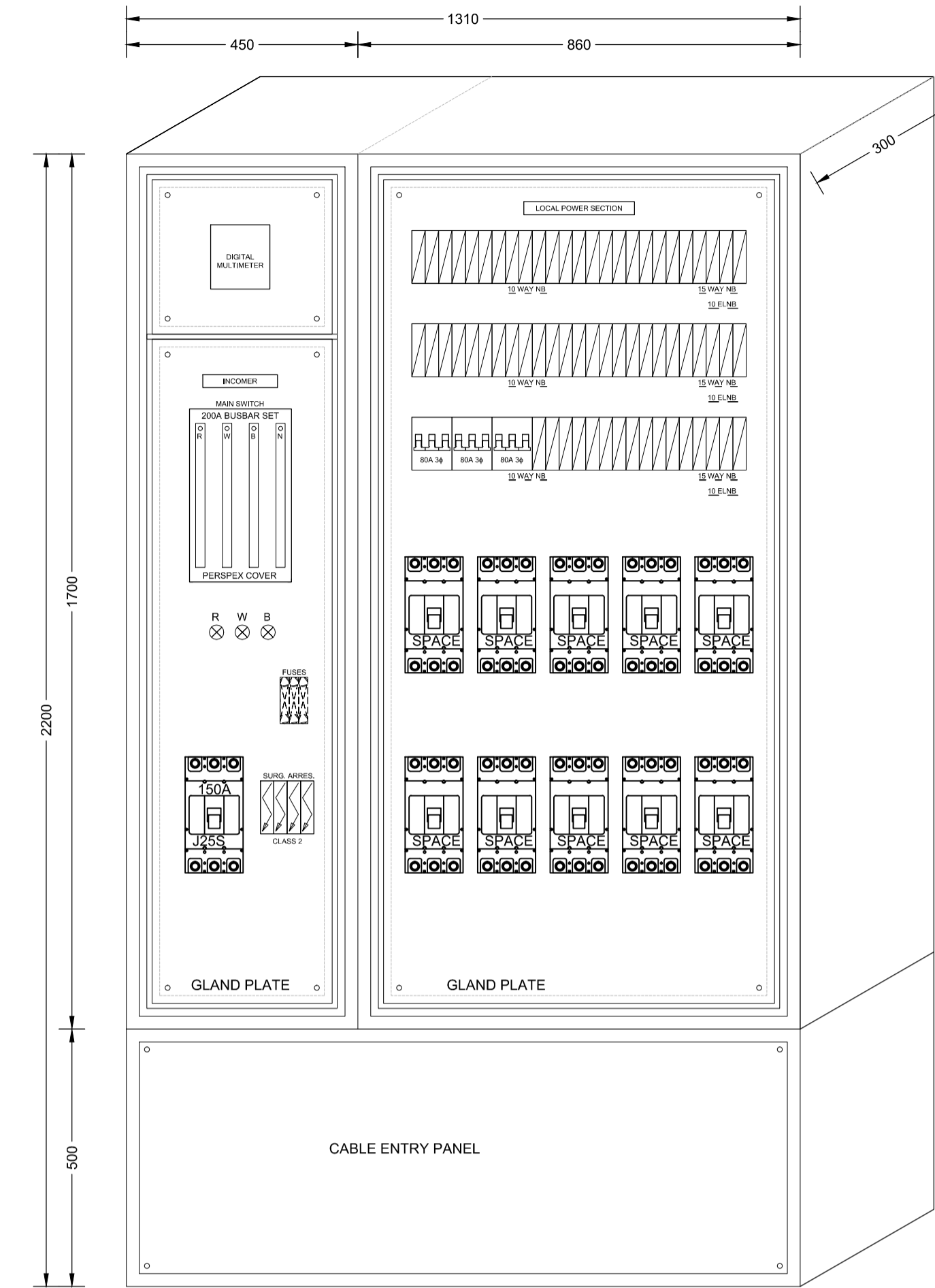

ESSENTIAL DISTRIBUTION BOARD

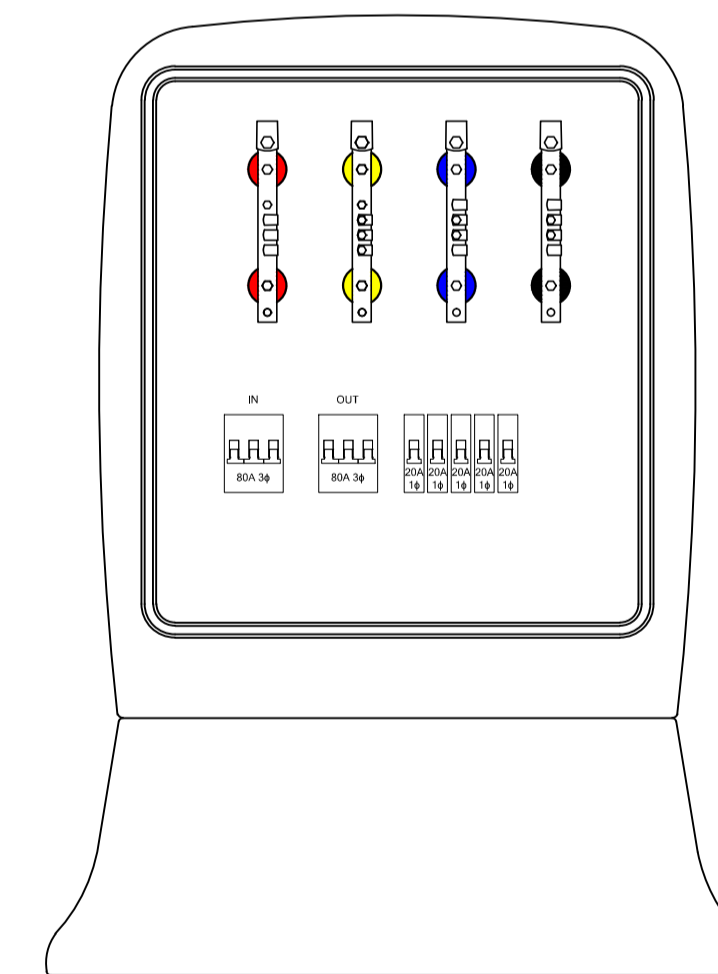

TYPICAL 9-WAY KIOSK ELECTRICAL SECTION

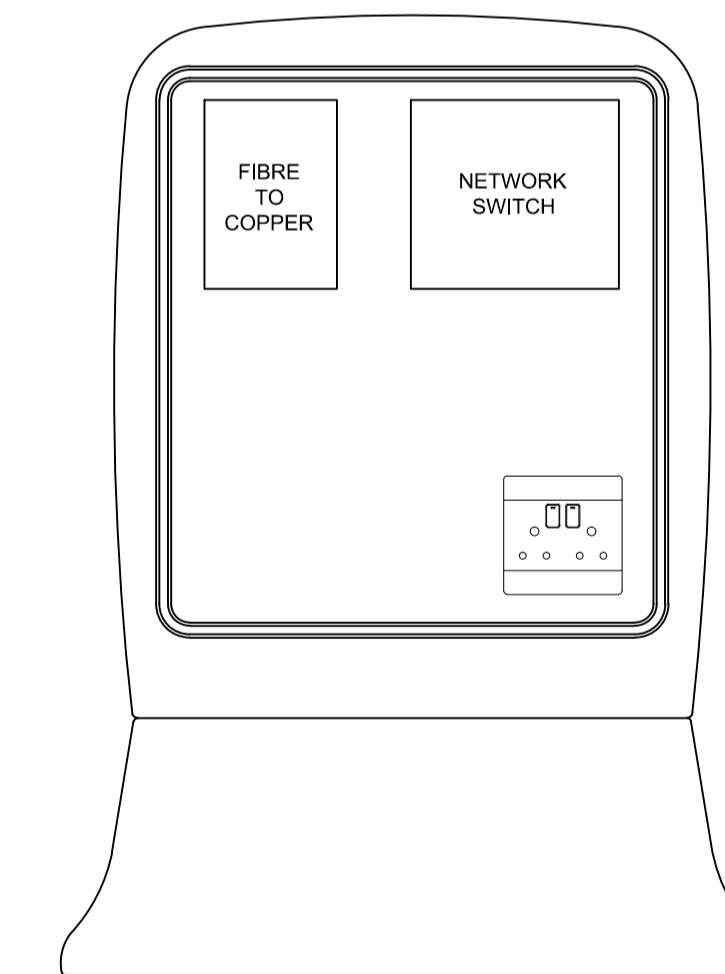

TYPICAL 9-WAY KIOSK DATA SECTION

3ø CIRCUIT BREAKER & AMP RATING	3ø 80A CB
1ø ISOLATOR & AMP RATING	1ø 100A ISOL
3 PHASE INDICATOR (3ø)	3ø 20A CB
SINGLE PHASE INDICATOR (1ø)	1ø
DIGITAL MULTI METER	DM
EARTH LEAKAGE	EL
DAY/NIGHT LIGHT SENSOR	☀

NR. NO.	DATE	WYSIGINGS AMENDMENTS
0	2024/08/22	FOR INFORMATION ONLY
1	2024/11/18	FOR TENDER ONLY

Copyright of drawings:
This drawing is the property of BDE Consult & the copyright therein vests in BDE Consult & may not be copied in whole or in part, nor may the technical contents be used for any reason whatsoever without the written permission of BDE Consult.
The drawing shall be returned to BDE Consult on request.

General Notes:
This drawing is to be read in conjunction with relevant layout drawings, specification & BOQ.
The contractor / OEM vendor to submit shop drawings & fabrication drawings for client / consultant's approval before commencement of fabrication / procuring components.

CLIENT / CLIENT
ACSA

BDE
RAADGEWENDE INGENIEURS
CONSULTING ENGINEERS

■ KAAPSTAD P.O. BOX 53058 KENILWORTH 7745 TEL. (021) 696 4065
■ GEORGE P.O. BOX 1862 GEORGE 6530 TEL. (0441) 801 9700
■ E-MAIL: info@bdeconsult.co.za

CESA

PROJEK / PROJECT
ACSA LANDSIDE PARKING SECURITY

TEKENING BESKRYWING / DRAWING DESCRIPTION
SCHEMATIC DIAGRAM & TYPICAL DETAIL LAYOUTS

TEKENING NR. / DRAWING NO.	REV
GRG-510/RT/SC/02	1

HUIDIGE DATUM / CURRENT DATE	2024/11/18	GOEDGEKEUR / APPROVED
SKAAL / SCALE	A1 - NTS A3 - NTS	NAGEGAAN / CHECKED
LEARNR. / FILE NO.	00510 GRG	CAD NAGEGAAN / CAD CHECKED
AANVANGSDATUM / COMMENCE DATE	2024	GETEKEN / DRAWN
		UDJ

FOR TENDER ONLY